



**TECHNOLOGIES FOR
PROCESSING VALUE-ADDED
BERRY FRUIT PRODUCTS**



Table of Contents

| | |
|--|-----------|
| Introduction | 3 |
| Fruit Harvest Maturity and Storage Conditions..... | 5 |
| Frozen Berries | 8 |
| Processing Line for Frozen Berries..... | 9 |
| JBT IQF Freezer..... | 10 |
| Keys to Effective Freezing of Berries..... | 12 |
| Berry Puree | 13 |
| Puree Extraction: Impact of FTE Parameters..... | 13 |
| Processing Line for Berry Puree | 14 |
| Rotor Angle and Speed..... | 16 |
| Screen Size and Gap..... | 17 |
| The Myth about Pomace Moisture Content and Yield | 18 |
| Radio Frequency Heating | 19 |
| Berry Juice..... | 20 |
| Processing Line For Berry Juice | 21 |
| JBT READYGo™ VEGETABLE/FRUIT Skid | 22 |
| Pasteurization/Sterilization..... | 23 |
| JBT Sterilizer Types..... | 23 |
| Quad Tube Design..... | 24 |
| Stork Sterideal® Coil | 25 |
| Berry Juice/Puree Concentrate | 26 |
| Evaporator Working Principle..... | 27 |
| Aseptic Filling..... | 28 |
| Providing Solutions, Not Just Machinery | 29 |
| References..... | 30 |

Introduction

Berry fruits are processed to form value-added products such as juice, puree, concentrate and frozen berries which are widely used in preparation of beverages, ice cream, yogurt, milkshakes, jams, jellies, smoothies and many other food products. The production of berries for food processing has been steadily growing, indicating a growing demand for value-added berry fruit products (**Fig. 1**).

This paper reviews some of the major unit operations and processing parameters involved in the production of high quality juices, purees, concentrates and frozen berries.

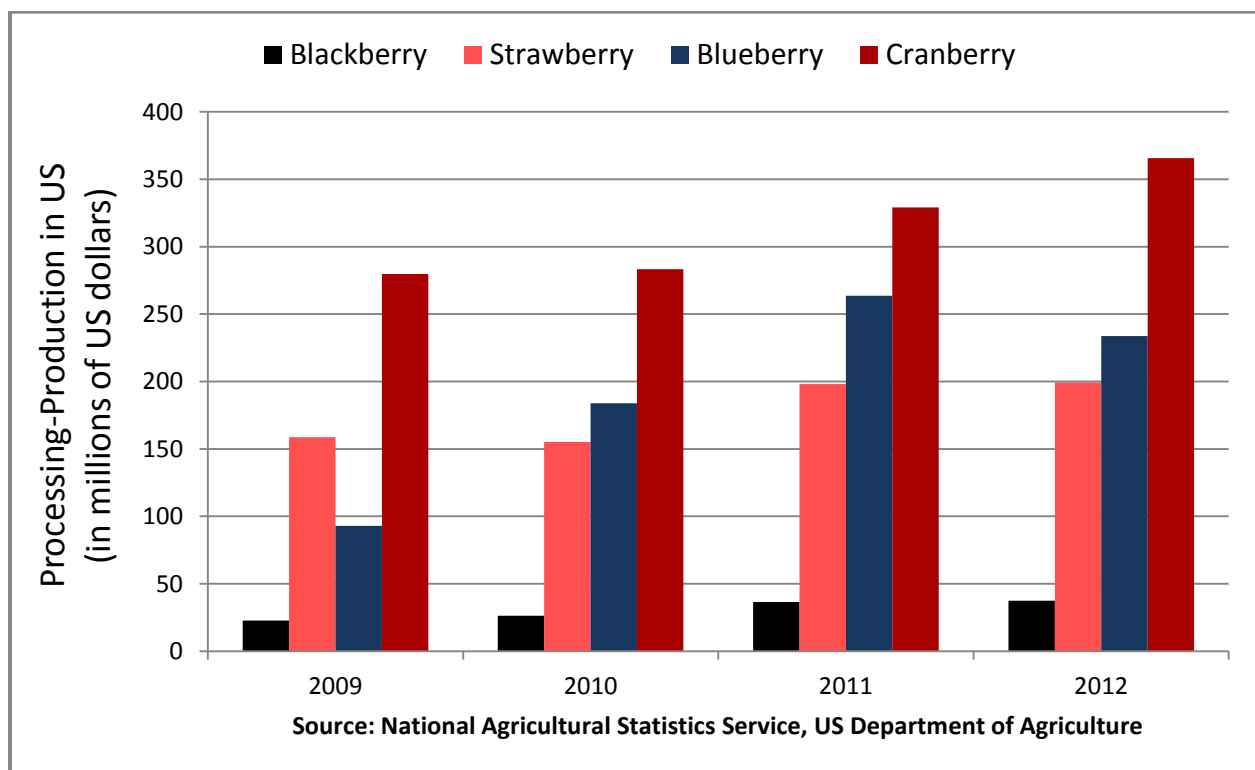

Fig. 1 – Berry Production for Processing in U.S.

Berries are fruit crops known for their distinct colors, flavors and textures. Commonly consumed and commercially cultivated berry fruits include:

- Blackberry (*Rubus* spp)
- Black Raspberry (*Rubus occidentalis*)
- Blueberry (*Vaccinium corymbosum*)
- North American Cranberry (*Vaccinium macrocarpon*)
- Red Raspberry (*Rubus idaeus*)
- Strawberry (*Fragaria x ananassa*).

Though horticulturally classified as "berry fruit," none of these fruits are a true berry in the strict botanical sense. Cranberry and blueberry are considered false berry fruits owing to their derivation from an inferior ovary rather than a superior ovary, whereas blackberries, raspberries and strawberries are classified as "aggregate fruits (Mitcam, 2007)."

Table 1 summarizes key morphological differences in berry fruits.

Extensive research on the compositional elements of berries and their biological activities has established the profound advantages of berry intake. Berry consumption has shown to positively influence various adverse health conditions such as aging, obesity, cardiovascular and neurodegenerative diseases.

These desirable characteristics are often attributed to the high flavonoids, vitamins, minerals and fiber content in berries. Berry phenolics include flavonoids, tannins and hydrolyzable tannins. It is worth noting that both lipophilic (minor) and hydrophilic (major) phytochemicals are found in berries and it is their synergistic effects that brings the wide range of observed biological and physiological properties (Seeram, 2008).

TABLE 1. BERRY FRUIT MORPHOLOGY

| PARTICULAR | CLASS | | | |
|----------------------|---|--|--|--|
| | FALSE BERRY | AGGREGATE FRUITS | | |
| | | AGGREGATE OF ACHENES | AGGREGATE OF DRUPES | |
| COMMON NAME | Cranberry and Blueberry | Strawberry | Blackberry | Red Raspberry |
| BOTANICAL DEFINITION | Berry-like fruit derived from an inferior ovary unlike berry fruits | Fruit consisting of many individual small achenes or drupes derived from separate ovaries within a common receptacle | | |
| LOCATION OF SEEDS | Seeds are embedded in the lignified endocarp distributed within fleshy mesocarp | Achenes contain single seed that nearly fills the pericarp | Each drupe contain a single seed enclosed within an endocarp shell | |
| RECEPTACLE | Not present in the fruit | Fleshy part of the fruit that holds the achenes | Remains attached to the clusters of drupes at harvest | Separates out from clusters of drupes at harvest |

Fruit Harvest Maturity and Storage Conditions

Berry and berry-like fruits are generally small (5–25 mm diameter) with a characteristic soft flesh that lacks a peel or inner core, making them highly perishable (Bates, Morris, & Crandall, 2001). The soft flesh is more susceptible to physical and insect damage and, therefore, berry fruit must be handled and stored carefully prior to downstream processing.

The following are the important pre-processing parameters that can affect the quality of value-added berry products (Mitcham, 2007):

1. Harvest maturity and cultivar type: Affects the total soluble content, degree of firmness, total antioxidant capacity and phenolics of berry fruit.
2. Post harvest storage conditions: Helps in maintaining the fresh fruit qualities and prolonging the shelf life of the fruit.

The ripening of fruits is a complex process often associated with an increase in soluble solids, total sugars, total ascorbic acid, pH, and water soluble pectins, and a decrease in acidity, total phenols, and activities of polyphenol oxidase and peroxidase. The extent of ripening governs the maturity of fruits. Berries should be harvested at a near full ripe stage to retain the sweetness and appropriate flavor as the soluble solids content of berries remain unchanged post harvesting (Mitcham, 2007).



Premature harvesting of berries has been associated with lower anthocyanin content (pigment responsible for berry fruit color), lower sugar content and greater degree of firmness. In addition, harvest maturity is also known to influence the total antioxidative capacity, vitamin content, phenolics content and volatiles content, thereby altering the overall nutritional value of berry fruit.

Similarly, different cultivars of berry fruits are known to have different quality. Cultivar selection has an immense influence on sensory, micro-structural and chemical properties of berry fruit. Any variation in quality of berry fruit processed for value addition ultimately affects the quality of final product.

Rapid cooling of berries post harvest is often necessary to reduce the respiration rates and enzymatic activity that lead to softening of berry fruits. Cooling also prevents microbial growth, causing a prolonged shelf life (Bower, 2007). The respiration rates vary not only with the different types of berry fruits, but also with the cultivar type and degree of maturity of the same berry fruit.

Optimum cooling temperature varies with the change in type, cultivar and the degree of maturity of a berry fruit. Cooling is often accompanied with loss of moisture which can cause shriveling of berry fruit. Thus, proper humidity control in refrigerated storage is an important parameter for consideration.

Table 2 defines the conditions of maturity and post-harvest storage for commonly consumed berry fruits.



TABLE 2. PRE AND POST HARVEST FRUIT QUALITY

| FRUIT QUALITY PARAMETER | COMMON NAME | | | | |
|--|--|---|--|---|--|
| | Cranberry | Blueberry | Strawberry | Blackberry | Red Raspberry |
| Respiration Rate ¹ | Low, longer storage life | | | High, shorter storage life. | |
| Maturity ¹ | > ³ / ₄ skin color development to pink or red color; minimum diameter of 10.3 mm | Full color development; 9–11.5 °Brix; 0.5–1.15 citric acid equivalents titratable acidity | More than ¹ / ₂ or ³ / ₄ of skin color should be red or pink; >7 °Brix; <0.8% titratable acidity | Full color development to shiny black stage; Pink color development due to loss of pigment caused by harvest of less mature fruit | Full color development; easy detachment from plant; ~ 11 °Brix; ~ 1.4% titratable acid |
| Weight of Mature Fruit (g) ² | 1–1.5 | 0.5–3 | 3.5–15.5 | 3–12 | 2.5–5 |
| Anthocyanin Content (mg/100g Of Fresh Fruit) ³ | 140 ± 28.5 | 386 ± 77 | 21.2 ± 3.3 | 245 ± 68 | 92.1 ± 19.7 |
| Post Harvest Storage Temp (°C) ⁴ | 2.0–4.0 | 0.0–0.5 | | | |
| Post Harvest Optimum Humidity (%) ⁴ | 90–95 | | | | |
| Post Harvest Shelf Life ⁴ | 2–4 months | 2–3 weeks | 5–7 days | 2–3 days | 5–7 days |
| Reference: 1 – Mitcham, 2007 ; 2 – Strik, 2007; 3 – Wu et al., 2006; 4 – Bower, 2007 | | | | | |

Frozen Berries

The market for frozen berries is huge. In 2004, US alone produced roughly 700 million pounds of frozen berries (Zhao, 2007)

Though harvesting, post-harvest cooling, sorting, packing, storage and transport of berry fruits are equally important and vital for maintaining the quality of value-added product, it is the freezing process that is the most critical step from the processing standpoint for producing frozen berries and other value-added products.

The major advantage of freezing berries prior to processing is the disruption of tissue structure that helps in improving the extractability of juice/puree (Zhao, 2007).

Freezing is generally a two-step process involving supercooling of water and crystallization. Like any other processing step, the efficiency of freezing depends on several factors.

Factors that affect freezing rates are (Zhao, 2007):

1. Temperature difference between berry fruit and cooling air
2. Air velocity of cold air (cooling medium)
3. Initial berry fruit temperature
4. Type of freezing equipment used
5. Product characteristics such as composition, structure, size, and shape.

Individually quick freezing (IQF) is one of the fastest ways of freezing small fruits, such as berries. Efficient heat transfer, short freezing times, and less product dehydration are some of the many advantages of the IQF process.



Processing Line for Frozen Berries

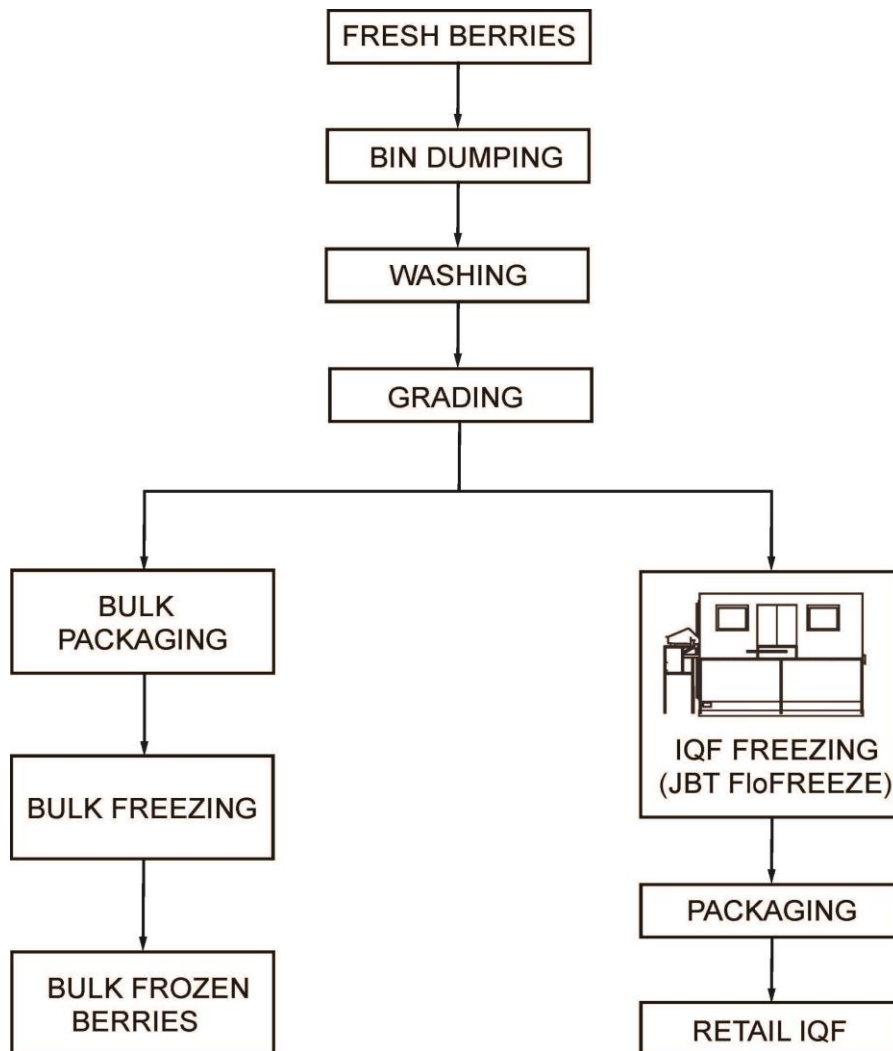

JBT IQF Freezer

The JBT Frigoscandia FloFREEZE® freezer, with its IQF (Individual Quick Frozen) track, ensures gentle handling of fresh berry fruits. JBT Frigoscandia pioneered the fluidization process for individually quick frozen (IQF) products, installing the first IQF freezer in 1962.

Fluidization involves quickly freezing each piece of berry separately, using refrigerated air that is blown at a high velocity on a "fluidized" bed. Put simply, fluidization means that the berries behave like fluid, suspended on a cushion of refrigerated air, as it "floats" throughout the freezing process.

The primary product parameter that influences the energy transfer during fluidization process is the mass of the product. Freezing rates for various berries frozen with IQF track of FloFREEZE are shown in **Fig. 2**.

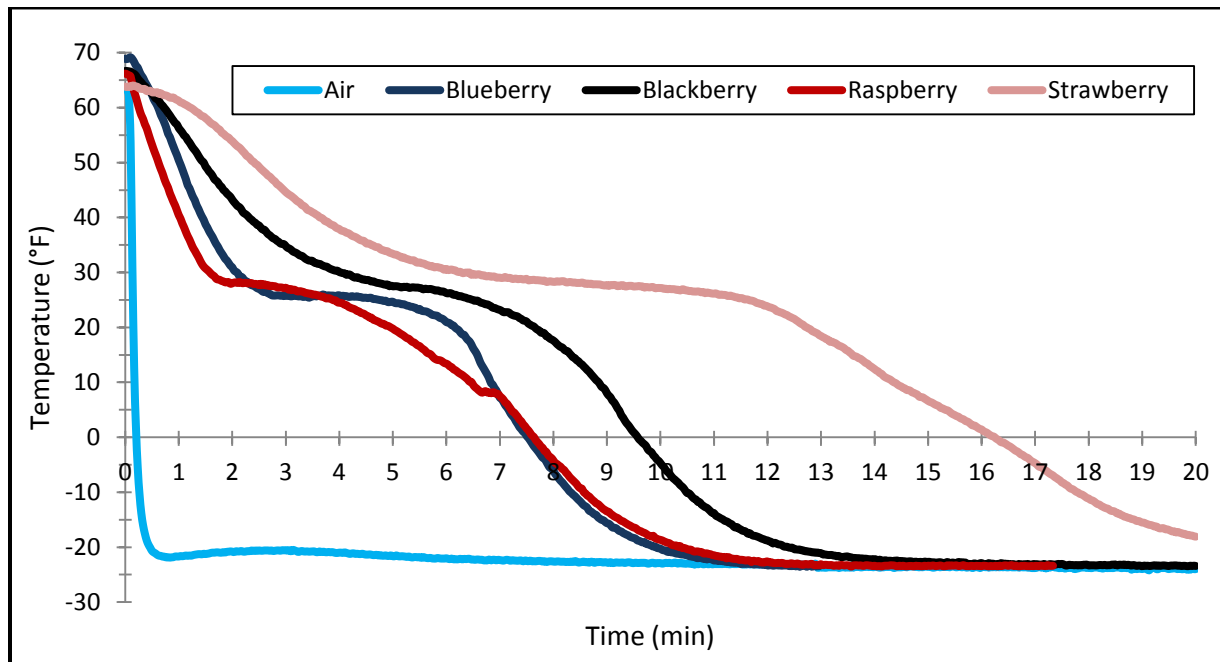

Fig. 2 – Variations in Freezing Rates of Berry Fruits Frozen with IQF Track of JBT FloFREEZE

Source: JBT Corporation

FloFREEZERS deliver higher air velocity (around 15 meters per second), resulting in a heat transfer coefficient that's more than three times higher than traditional linear freezers. This higher rate of heat transfers — the very heart of “quick freezing” — ensures superior quality. Among its many versatile features and options, the FLoFREEZE® IQF freezer features following remarkable concepts:

1. FloFREEZERS can adjust the air pressure during fluidization, making it capable of freezing a wide range of berries of different shapes, size and weights.
2. IQF tracks can be optimized with a patented agitation feature that moves the track in a jerky motion, improving the fluidization by enhancing the track's ability to “break up” or separate individual berries.
3. FloFREEZERS make use of a pulsating air flow through the IQF track, vertically separating the berry pieces from each other, preventing “cluster freezing.”
4. FloFREEZERS have an optimal patented optimized airflow feature for differently sized/shaped berries in the initial freezing zone.

There is no other process like fluidization, which is perhaps why the FLoFREEZE is the freezer of choice for food manufacturers around the world for quick freezing of berry fruits. Processes such as “semi-fluidization” aim to mimic the advantages of actual fluidization. However, partial lifting of the berry fruit in a semi-fluidization process impedes the heat transfer rates from the berries leading to inefficient freezing.

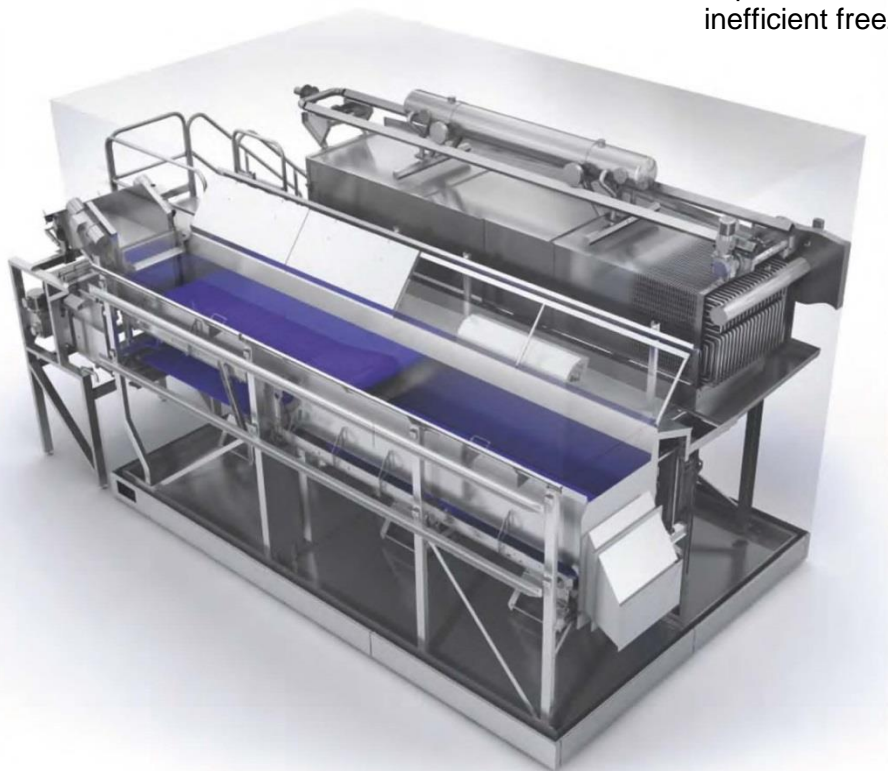

Keys to Effective Freezing of Berries

The primary goal in food freezing is to maintain as much of the original characteristic product quality as possible. This is normally achieved by freezing rapidly and by careful handling before and after freezing. But, the balance between quality and economics must be considered. There is a trade-off between speed and economics in freezing and economics often dictate the speed of freezing.

If the consumer cannot detect a difference in quality or is not prepared to pay for the difference, then the extra cost for faster freezing cannot be economically justified. The cost of dehydration weight loss must also be pulled into the equation because this cost can often exceed all other costs of freezing.

Since most foods that are frozen are 55% to 95% water, formation of ice crystals can be a major source of product degradation.

As ice forms, water is withdrawn from the solution inside the food cells, concentrating solutes inside the cell. If the freezing is rapid, a large number of ice crystals will form within and between cells.

If freezing is slow, the initial crystals formed will simply grow, developing a smaller number of very large crystals between cells. These large ice crystals and the withdrawal of water from the cells can break down food structures, resulting in high drip losses and a deterioration in quality.

Drip loss refers to the juices lost as product thaws. The formation of large ice crystals increases drip loss. This may have a significant effect on the texture and the flavor of the product tissue. From a practical point of view, freezing time is the biggest contributing factor to drip loss. The longer the freezing time, the larger the ice crystals and, therefore, the higher the drip loss.

DRIP LOSS IN STRAWBERRIES FREEZING TIME

12 min. (7.5% Drip Loss)
"Good"

20 min. (14% Drip Loss)
"Acceptable"

90 min. (21% Drip Loss)
"Bad"

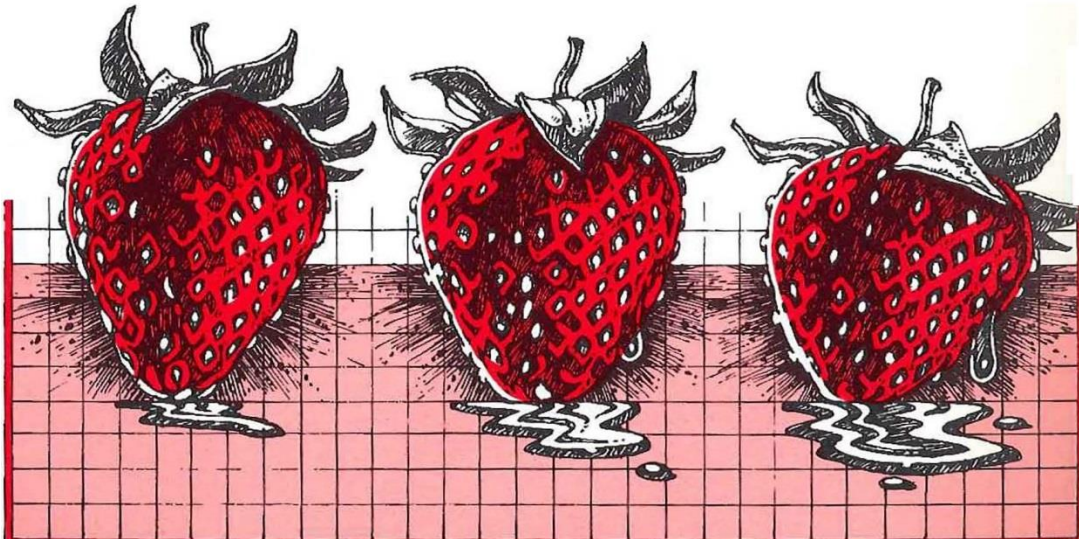

Source: JBT Corporation

Berry Puree

The pulp containing viscous and totally fruit based paste obtained by the mechanical process from sound ripe fruit is referred as puree (Bates, Morris, & Crandall, 2001). Almost every fruit can yield a juice if required, however, for fruits such as berries; puree serves a better purpose for some commercial applications. Chopped, heated/unheated berry chunks from a feed tank can be processed via the FTE line of JBT turbo finishers. The FTE Finisher can also be made to work as a cold extractor for the whole berry fruit by changing the product inlet hopper and adding a pre-rotor with six knives (**Fig. 3**), thereby combining the size reduction step and refining step in a single operation.

The rotors, with the help of centrifugal speed, push the chopped product towards the inner surface of the screen allowing the separation of puree from seeds and peel; a larger screen size can also be employed to retain seeds in the puree. The top part of the rotor blades and holes of the screen are aligned with perfect precision, allowing smooth cutting of the berry fibers and permitting the mashing of berry fruit components into a homogenous puree. Puree quality and yield can be controlled by varying the following FTE parameters:

1. Rotor angle and speed
2. Screen angle
3. Gap distance between screen and rotor

Puree Extraction: Impact of FTE Parameters

The rotor paddles (18 paddles per rotor) are offset at 2.5° or 5° angle with higher angle resulting in a lower residence time. On the FTE 100, it is possible to stagger the rotors in an offset configuration to facilitate aggressive extraction which is typically used when sticks and stems are present.

Hygienic design of the rotors is devoid of any bolts or catch points, preventing accumulation of material inside the finisher.

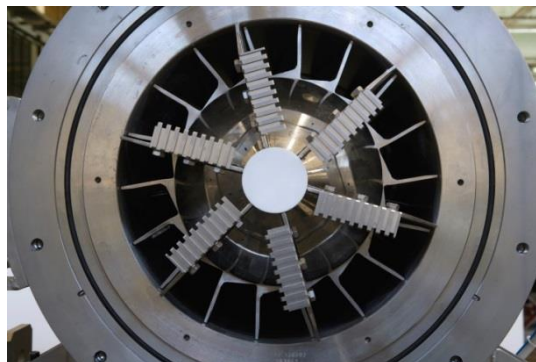
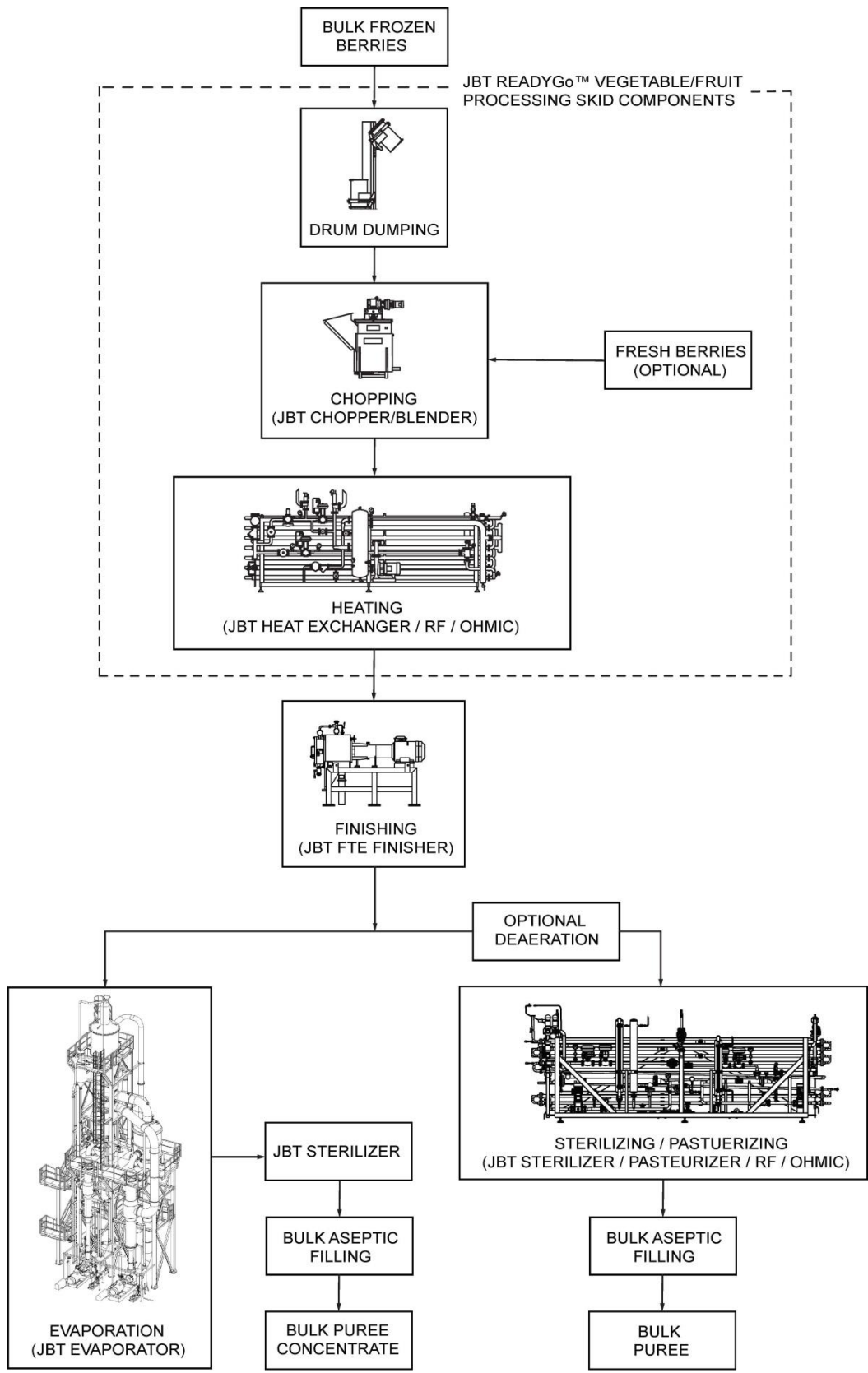

Fig. 3 – Pre-rotor with Knives

Processing Line for Berry Puree



FTE TURBO FINISHER: POWERFUL PARTNER TO THE PUREE INDUSTRY

The Turbo Finisher is designed for puree production from chopped chunks of berry and other vegetables/fruit

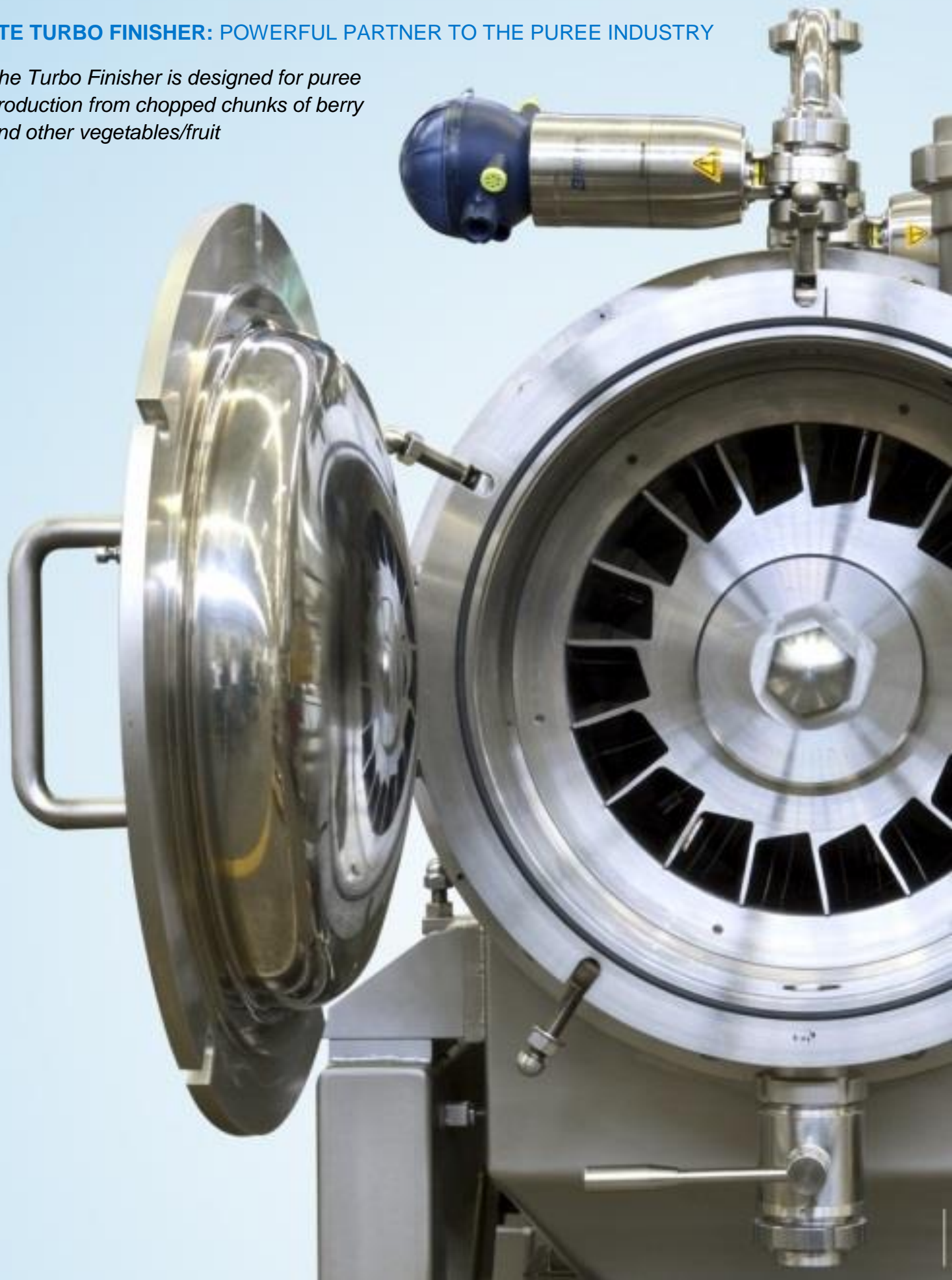

Rotor Angle and Speed

The rotor speed directly relates to the centrifugal push provided by the rotor blades. Higher rotor speed results in shorter residence time and higher centrifugal force push onto the incoming feed, often yielding higher amounts of puree. Conversely, lower rotor speeds result in higher moisture content in pomace yielding less amount of puree, as can be seen in case of blueberry puree (**Fig. 4**).

Different rotor angle and speed settings offer flexibility in terms of varied feed residence times, ultimately affecting the quality and yield of puree.

The following correlation exists between puree yield and FTE Finisher parameters:

$$\text{Puree Yield} \propto \frac{1}{\text{Pomace Moisture Content}} \propto \text{Rotor Speed}$$

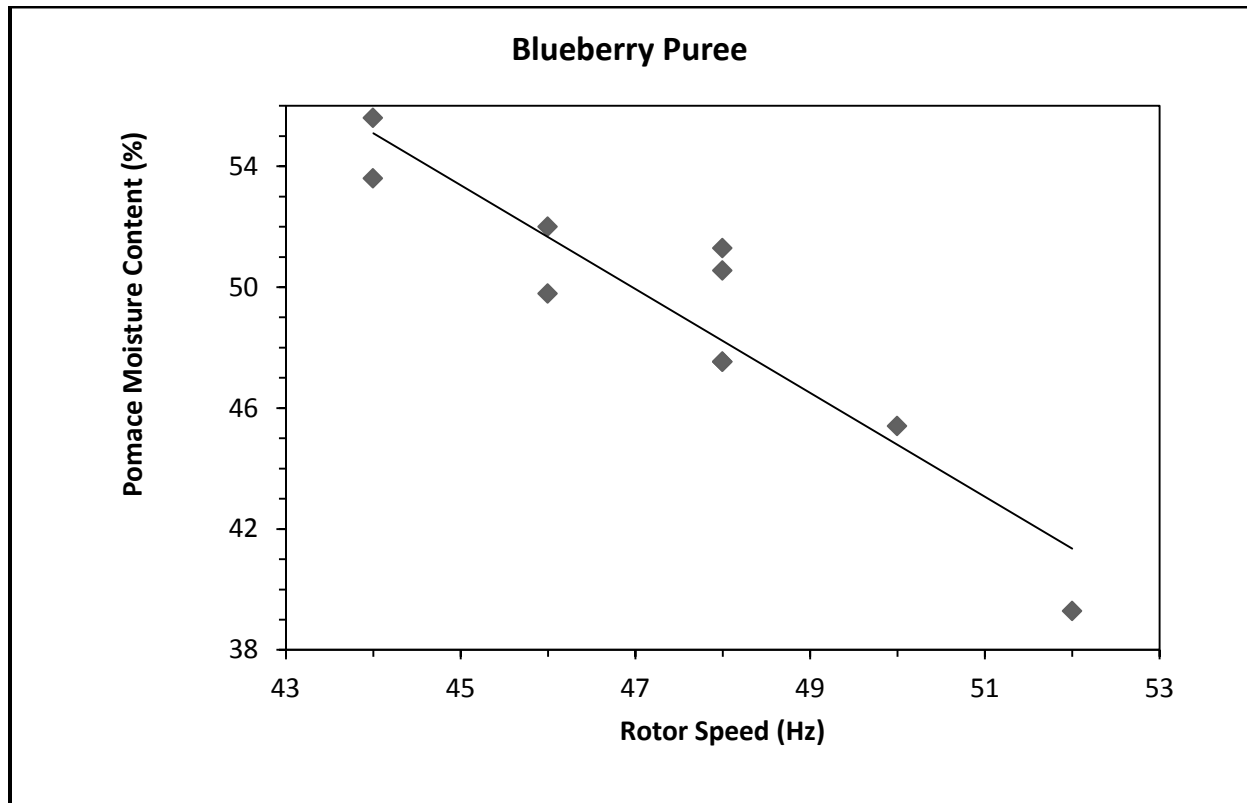

Fig. 4 – Rotor Speed vs Pomace Moisture

Source: JBT Corporation

Screen Size and Gap Distance

The screen acts as a primary element of separation in the FTE finisher. The screen size is determined by the desired particle size of the material being processed. The size of the pore determines the fiber dimension and quantity of material finished.

The FTE screen comes in a variety of pore sizes and thicknesses. Berry puree processing requires sizes anywhere in between 0.6–1.0 mm, depending on the type and cultivar of berry. Minor changes in screen pore size can significantly alter the quality and yield of puree. Keeping all other parameters fixed, a larger screen size yields higher viscosity, higher soluble and insoluble solids, higher volatiles and antioxidants.

Screen rotor clearance or the gap distance between screen and rotor can be set with an external wheel while the machine is in operation by changing the axial position of the screen as it relates to the rotor. In principle, a narrower gap between screen and rotor results in stronger puree extraction along with higher power absorption. A screen rotor gap of 0.9–1.0 mm provides optimum clearance, resulting in higher yields and better quality berry puree.

In a real time scenario, there are numerous variables that impact yield and quality. Therefore, best results are obtained by an optimum interplay of above mentioned parameters. Any minor inconsistency observed can be attributed to minor changes in feed flow rates and differences in the feed fruit morphology and quality. Given the variations in quality of fruit, one or more FTE operating parameters can play a dominating role in determining the yield and/or quality attributes of puree. At constant feed flow rate and temperature, a larger screen size and higher rotor speed yields more viscous puree.

The Myth About Pomace Moisture Content and Yield

Percent pomace moisture content is often loosely related to the juice/puree yield. A common misconception is that pomace moisture content is linearly related with yield i.e. 2% drop in pomace moisture corresponds to 2% increase in juice/puree yield. However, the relationship is more complex than the presumption. It is true that higher moisture content of pomace corresponds to a lower yield, however, it becomes increasingly difficult to increase the yield as the pomace becomes dryer; e.g. blueberry puree yield increased by 0.3% when pomace moisture content dropped from 40% to 35%; whereas it went up by 0.9% when pomace moisture content reduced from 60% to 55% (**Fig. 5**).

The relationship can be attributed to, 1) changes in the food matrix such as loss of cellular structure and chemical composition that occurs due to finishing operation and, 2) the amount of pomace that can possibly come out as a waste stream.

As the pomace becomes dryer, it becomes harder to extract the puree/juice and soluble solids possibly due to lack of freely available water thereby reducing the extractability resulting in lower yield increase.

Fruit morphology is another key factor that determines the amount of waste stream leaving the finisher. For instance, tomato and apple will have very different amounts of waste stream post finishing. Similarly the cultivar and the fruit type influence the amount of pomace leaving the finisher. As can be seen in figure, for a similar drop in pomace moisture content, the blueberry puree yield increased more than strawberry puree yield because strawberry and blueberry have very different fruit morphologies. JBT recommends mass balance as a means of yield measurement compared to solely moisture content.

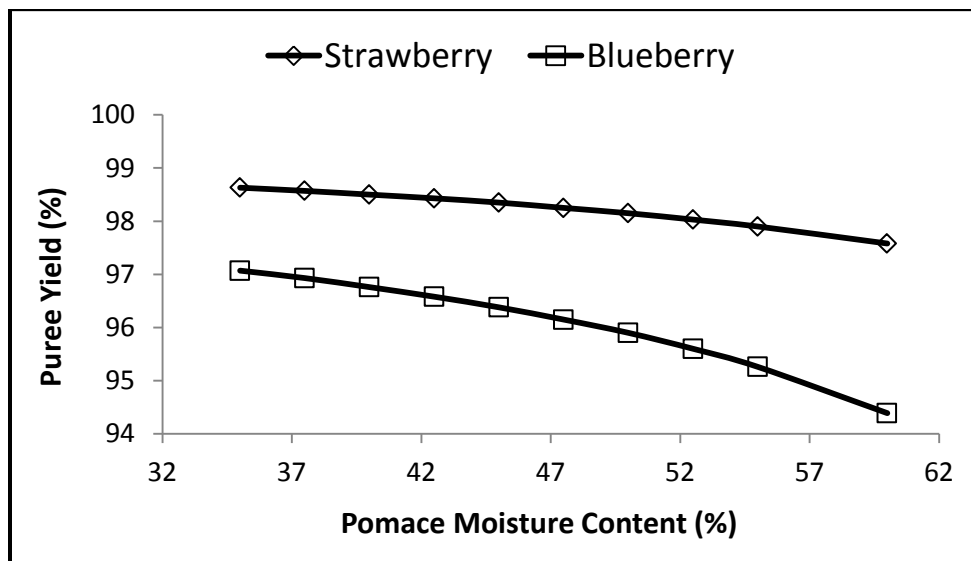

Fig. 5 – Non-Linear Relationship: Puree Yield vs Pomace Moisture Content

Source: JBT Corporation

Radio Frequency Heating

Radio frequency (RF) is an emerging technology for food heating operations due to uniform and rapid heating, lower energy consumption and greater penetration depths. Absorption of electromagnetic radiations of selected frequencies (13.56 ± 0.00678 , 27.12 ± 0.16272 and 40.68 ± 0.02034 MHz) causes ionic depolarization. Continuous reversal of polarity of electric field results in internal generation of heat in foods due to friction (Marra, Zhang, & Lyng, 2009).

Heating of liquid foods with particulates is an interesting application of RF heating. Conventional heating of liquid foods with particulates may yield products with degraded quality due to longer residence times in heat exchangers and non-uniform heating. Treatment of chopped berries using RF unit can lead to quick and uniform heating of berry fruit yielding significantly improved overall quality of final product.



A post finishing RF heating unit operation can be combined with conventional sterilizers to quickly sterilize the juice/puree/diced berries. Typical treatment involves continuous pumping of fluid substrate through one or more Teflon® tubes placed between specifically designed electrodes that may differ depending on the tube diameter and the physical characteristics of the product. The product is directly heated by the RF field, based on well-known principles of dielectric losses. The intensity of electric field, and consequent heating rate, is controlled by means of a variable capacity coupling circuit. Temperature of product obtained at exit is a function of the applied RF power and product flow rate. Heating rates from 1-2 °C/s (for highly viscous liquids containing suspended solids) up to 50-100 °C/s (for a low viscous liquid with no particulates) are possible. The temperature set point can be reached and controlled with an accuracy of ± 0.5 °C.

Minimal energy consumption and rapid and uniform heating ensures maximum profit margins. JBT has successfully installed RF heaters for commercial operations that involve pasteurization/sterilization of fruit bases for yogurt applications.

Berry Juice

The same processing line, with a change in finisher, can yield a high quality juice, thanks to JBT finishing (separation of juice from pomace) technology. The UCF (screw finisher) and UPF (paddle finisher) are more suitable for juice extraction purposes. With options of different sizes and throughput rates, the JBT family of finishers is designed from the ground up to handle the full range of berry juice finishing operations. All-stainless steel construction, a fully enclosed and guarded drive system, an adaptable intake to meet application requirements, and a spray ring to minimize screen blinding are some of the JBT design and development features that provide easy-to-clean and easy-to-operate systems.

A paddle finisher is appropriate for high volume juice finishing applications when low dryness control is not a critical parameter. Adjusting the gap between the paddles and the screen determines how much force is applied to the separation process. The remaining pomace is discharged through a weighted gate where a small amount of restriction is used to assist with further separation at the discharge outlet.

A screw finisher, on the other hand, uses a rotating screw to separate and dry pomace through a "plug valve" which provides back pressure against the exiting pomace as product material is separated. Controlling the air pressure of the plug valve manages the consistent dryness of the exiting pomace. Generally, screw finishers run at lower incoming feed flow rate to provide improved control over dryness. Depending on the berry fruit characteristics, throughput rates and plant set-up, processors can choose either of the two designs available with JBT's finishing technology portfolio.

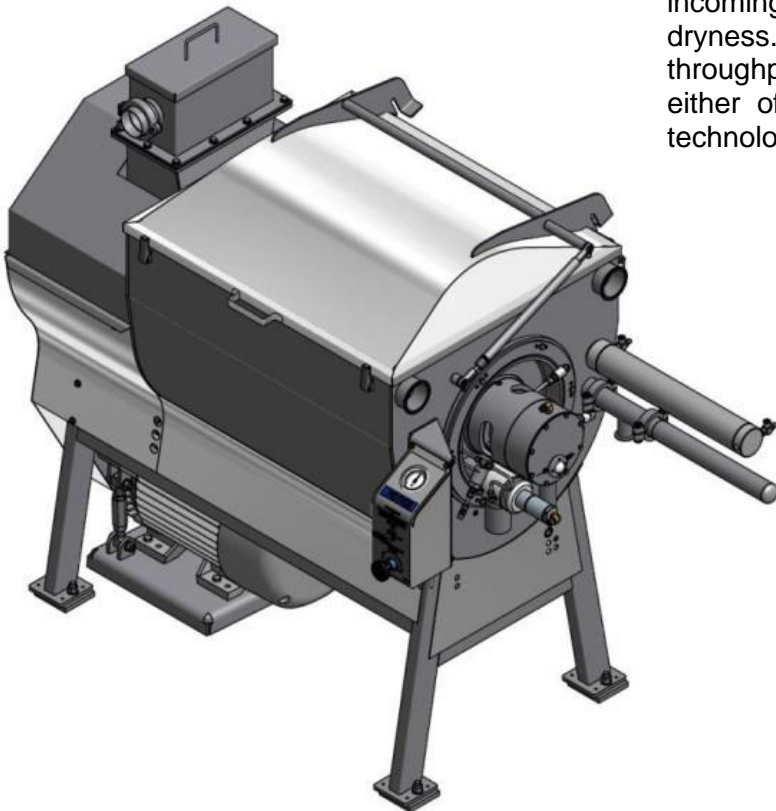

Processing Line for Berry Juice

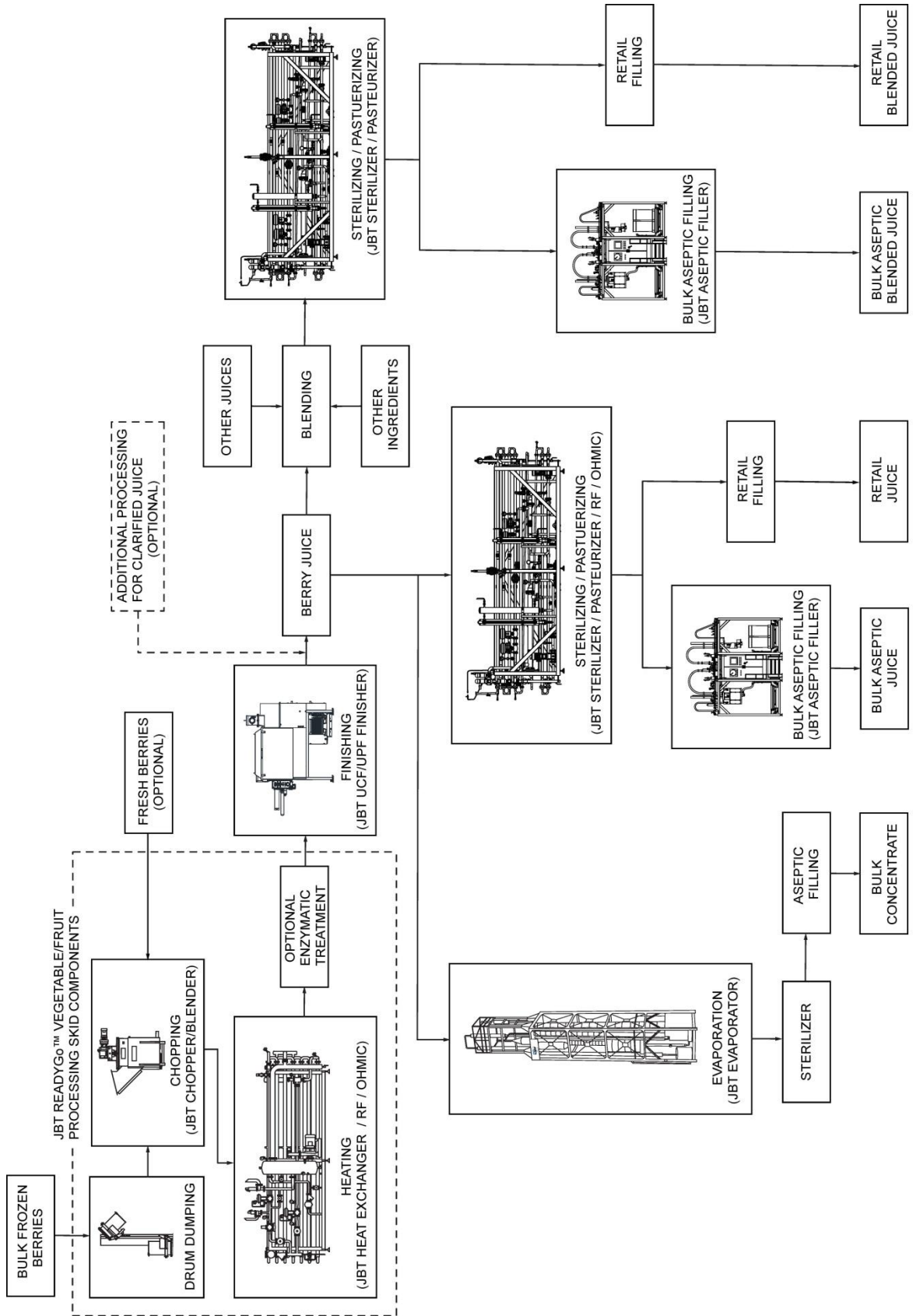

JBT READYGo™ Vegetable/Fruit Processing Skid

A series of primary processing steps including conveying, size reduction, and heat exchange operation are now integrated on to a skid which features extremely compact overall dimensions. This skid is part of JBT's READYGo™ series of processing skids meaning it is easy and quick to install, as well as flexible and easy to use. All the components are installed on a single stainless steel mainframe and are supplied with all the relevant piping and electrical connections.

The vegetable/fruit skid is designed to extract puree as well as juice from a variety of vegetable and fruits with batch sizes of 1000 kilograms or less as per the needs of processor. Ability to add different finishing (separation of juice/puree from pulp/pomace) technologies further downstream provides flexibility to the processor as the same system can be used for juice, puree and concentrate production. The presence of two heat exchangers with different sized tubes allows easy handling of low, medium and highly viscous fluids. The skid is primarily designed to conduct exploratory testing of different fruit and vegetable matrices as it comes equipped with a range of data recording sensors including a mass flow meter, pressure and level transmitters, but can also be used for commercial production capacity up to 20 gpm or 4500 lph.



Pasteurization/Sterilization

Thermal processing of food is designed to meet three objectives (Ramaswamy & Meng, 2007):

1. Reduction of microorganisms, both pathogenic and spoilage type to statistically insignificant levels
2. Creation of an environment that suppresses further microbial growth
3. Hermetic and/or aseptic sealing of package to prevent recontamination, post packaging and storage

Several factors need to be factored in while determining the extent of thermal processing including, but not limited to: 1) properties of food; 2) nature and type of spoilage and pathogenic microorganisms; and, 3) storage conditions. Fluid foods including berry puree are often subjected to surface heat exchangers to meet the thermal processing objectives. For a berry juice/puree, temperature requirements resulting in an effective thermal treatment can lie anywhere in between 90–115 °C, depending on the viscosity and density. For instance, the blueberry purees from "rabbit eye" and "high bush" varieties extracted under similar operating parameters of FTE had different viscosities (181 & 700 cP respectively). Sterilization of blueberry purees extracted from "high bush" and "rabbit eye" varieties will therefore require significant changes in thermal processing parameters. JBT offers different sterilizer designs meeting the needs of a variety of berry juices/purees having different flow behavior properties (**Table 3**).

JBT Sterilizer Types

TABLE 3. JBT STERILIZER DESIGN AND HEAT TRANSFER COEFFICIENTS BASED ON BERRY JUICE/PUREE VISCOSITY

| JUICE/PUREE VISCOSITY | STERILIZER TYPE | HEAT TRANSFER COEFFICIENTS (W/m ² •K) |
|-----------------------|---------------------------|--|
| High Viscosity | Quad Tube | 600—800 |
| Medium Viscosity | Stork Sterideal® Coil | >1000 |
| Low Viscosity | Dimple Multitube-in-Shell | >1000 |

Quad Tube Design

JBT tubular heat exchangers are available in various configurations including product hold and process controls to assure critical temperatures and hold times are satisfied. They follow a similar construction format with a single tube or number of smaller tubes enclosed within an outer shell. The key to an ideal thermal treatment lies in the design of heat exchanger. Berry puree, though generally categorized as medium viscous fluid, can still have a wide range of product viscosity and density. It is therefore imperative to enhance the heat transfer and limit the pressure losses while designing the sterilizer. Typically, a quad tube design heat exchanger would suffice for the requirements of highly viscous berry puree sterilization.

JBT Sterideal® QT (Quad Tube Design) heat exchangers come with specially designed fins, acting as static mixer, placed inside annular product space providing effective heat exchange even at low fluid speeds of high viscous products. The presence of these fins provokes dynamic turbulence, drastically improving the heat transfer efficiency by convection at low fluid velocity (**Fig. 6**).

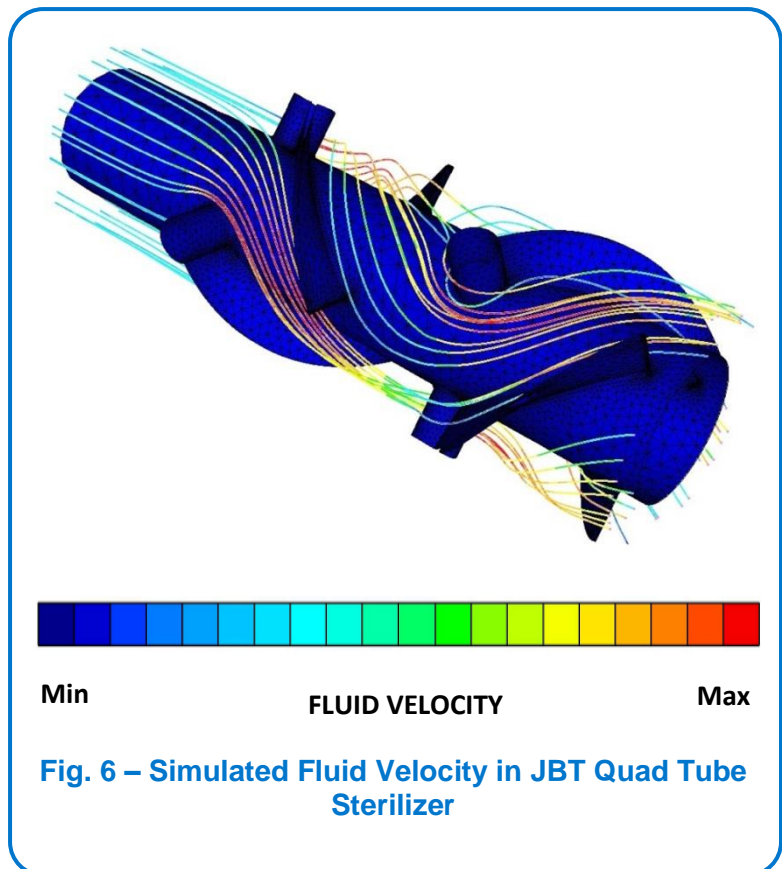

Sterideal Coiled Tube

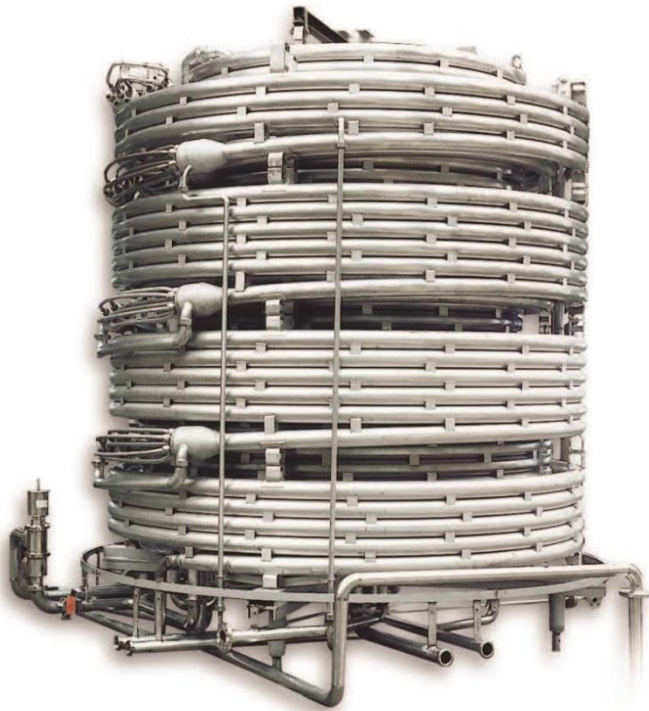

With over 50 years of experience in UHT processing and over 1000 worldwide installations, the Stork Sterideal® Coil sterilizer has been a reliable partner of food industry for sterilization applications. The most striking characteristic of the Stork Sterideal Coil is the continuous coil of the pipes. The heat exchanger consists of two or more concentric tubes. In the case of two concentric tubes, the product to be treated flows through the inner tube and the heating or cooling medium through the outer tube. For larger capacity, the Stork Sterideal Coil uses bundles of pipes in which several tubes (up to a maximum of seven) pass through a single common enveloping tube.

There are three main advantages of coiled tube design:

1. Continuous coiled tube design lacks blind angles, resulting in better cleanability due to reduced probability of fouling
2. A helically coiled tube has a favorable effect on the longevity of the heat exchanger, since coiled tubes are more resistant to thermal stress
3. Improved heat transfer due to the enhanced mixing caused by Dean vortices

Dean vortices represent a secondary flow perpendicular plane relative to the forward flow in the tube. These vortices cause mixing in the cross-section and ensure markedly improved heat transfer, during both heating and cooling.

Higher velocity, greater tube diameter and smaller spiral diameter results in higher Dean value. On the contrary, higher viscosity results in a lower Dean value. A remarkable increase in heat transfer for viscous products such as berry puree has been observed for coiled tubes due to an added convective heat transfer (**Fig. 7**).

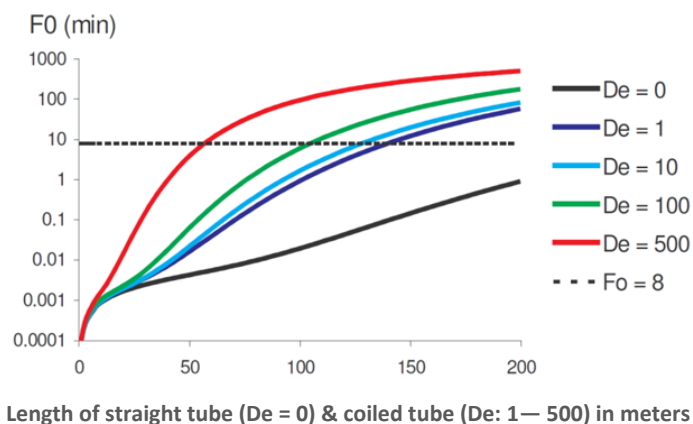

One great advantage of having a coiled tube heat exchanger is the significant reduction in tube length. Processing of medium viscous berry puree requires much shorter length of coiled tubes to attain higher temperatures. For a given F_0 value of 8 min, a coiled tube ($De = 500$) requires much shorter overall tube length (~ 50 m) compared with a straight tube ($De = 0$) requiring greater than 200 meters (660 feet) of tube length (**Figure 7**).

Fig. 7 – F₀ Values vs Tube Length

Berry Juice/Puree Concentrate

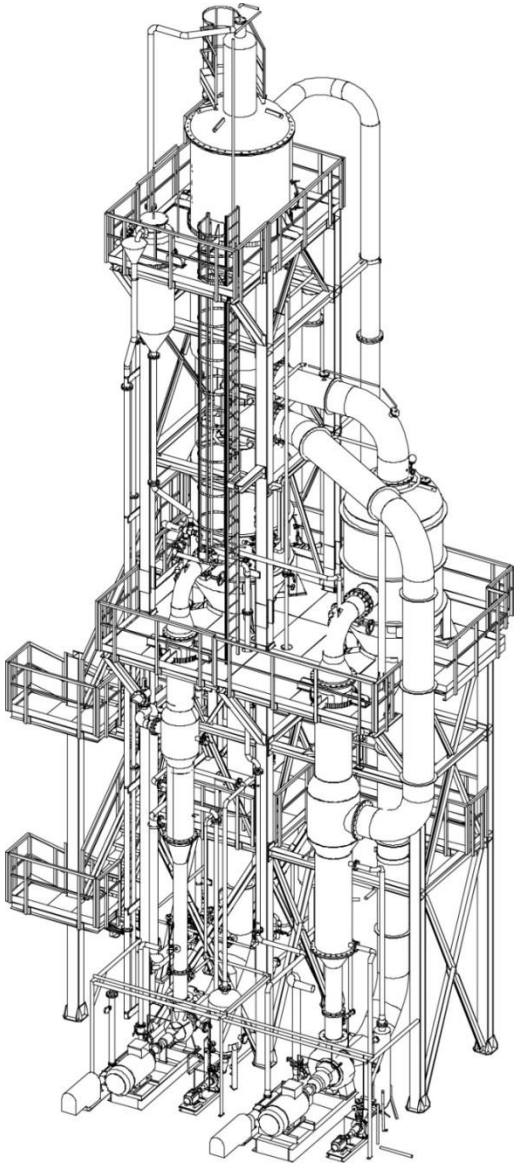

JBT Forced Circulation Evaporator

Concentration is an important step used to expel water from liquid foods for reducing its storage and transportation volume and improving shelf life. However, concentration is an intricate step requiring enough care to be taken to prevent any loss of volatiles and degradation of essential chemical compounds present in the liquid food. The quality of concentrate is hugely dependent on the flavor and aroma components and suspended solids in a liquid food. High quality concentrates can be obtained by (Thijssen, 1970):

1. Keeping lower process temperature and shorter residence time
2. Clean operation for minimizing any microbial activity
3. Selective dewatering to retain all components except water

The JBT T.A.S.T.E. evaporator (thermally accelerated short-time evaporation) is designed to stabilize and pasteurize berry juice during the pre-heating cycle and first evaporation stage. With over 200 units sold worldwide for various applications such as berries, citrus, and tomato, the T.A.S.T.E. evaporators can be used conveniently to form a berry juice concentrate (up to 45–68 °Brix) from berry juice (10–18 °Brix).

For a viscous puree with suspended solids, a special finishing stage involving forced recirculation is added to the T.A.S.T.E. pre-evaporator to form a hybrid evaporator which can provide over 3 times higher evaporation rates and can concentrate a berry puree (10–18 °Brix) up to 20–40 °Brix concentrate.

T.A.S.T.E. Evaporator Working Principle

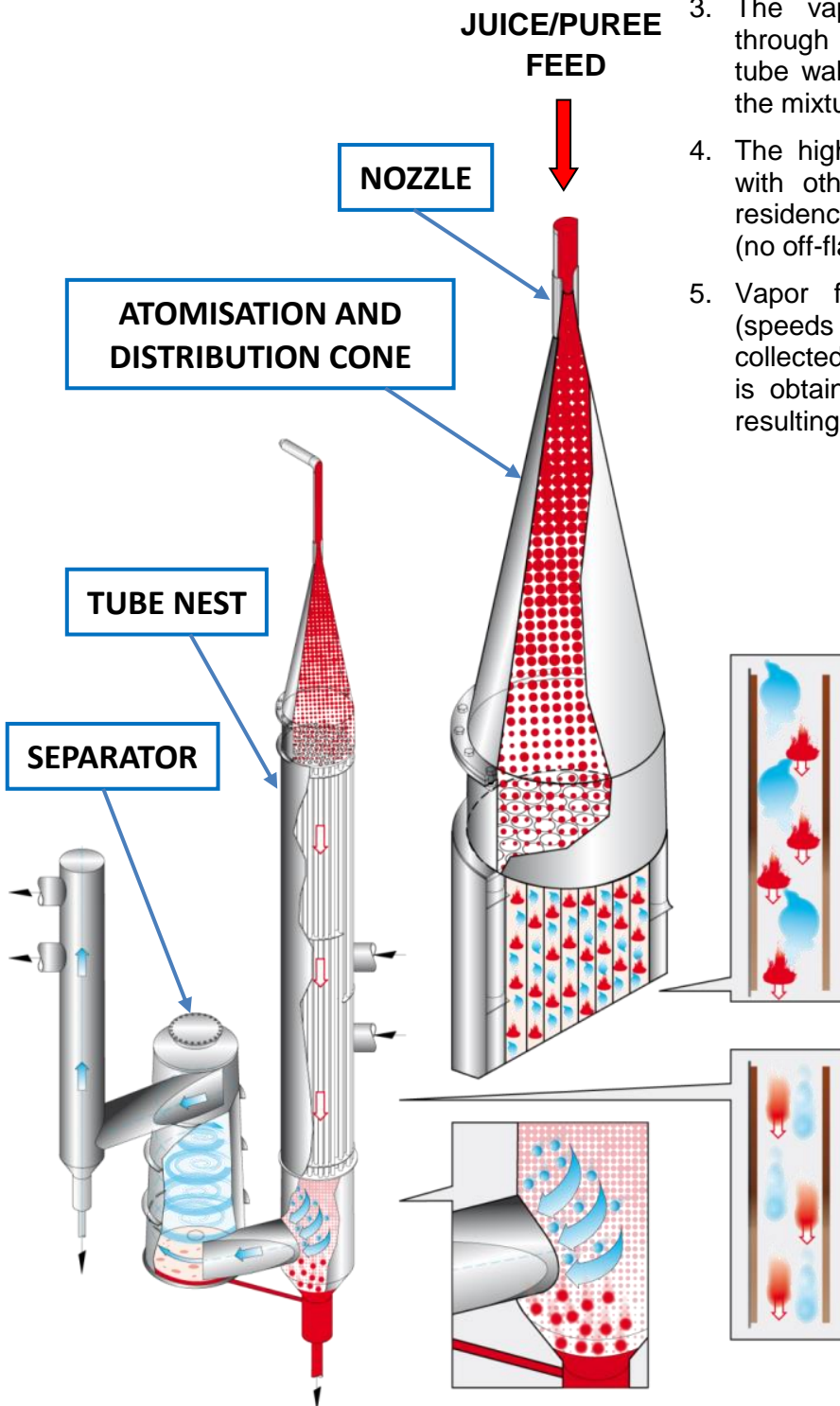

1. Juice is flashed off the inside of nozzle, then atomized and sprayed out into the distribution cone before reaching the top tube sheet.
2. Juice then enters the tube nest as a fog, a mixture of vapor and atomized liquid, expanding in the distribution cone and filling the exchange tubes in the stage body.
3. The vapor-liquid mixture accelerates downward through the tube nest as it absorbs heat from the tube walls. As the juice evaporates, the velocity of the mixture in the tubes increases.
4. The higher heat transfer rate obtained, compared with other evaporator designs, results in shorter residence time and minimal heat impact on the juice (no off-flavors and no burnt taste).
5. Vapor from the juice is efficiently centrifuged (speeds up to 700 km/hr) while separated juice is collected at the bottom. A better quality concentrate is obtained due to elimination of a recycling step resulting in much shorter residence times.

The T.A.S.T.E. evaporator can have multiple effects based on the needs of the plant and quality of juice/puree and can also be equipped with an ESSENCE & AROMA RECOVERY SYSTEM. The essence contained in the vapors of several stages is condensed into the essence condenser with the help of the cooling effect from the juice/puree and by a Freon-glycol refrigeration unit. The condensate is collected from a decant tank where the water (aroma) and oil (essence) phases are separated by gravity. The final aroma concentration can go as high as 150 fold.

Aseptic Filling

Continuous aseptic filling of berry juice/puree/concentrate is a standard benchmark for the berry industry. The JBT line of aseptic fillers offers a highly effective and reliable method of aseptically packaging bulk berry products.

JBT fillers use a revolutionary design filling tube which eliminates the traditional stem-and-plug configuration.

Years of research have led to development of the following features and advantages:

1. High production speeds
2. Improved reliability from a fully PLC-controlled, self diagnostic operational mode
3. Greater versatility by matching various packing and product standards and combinations
4. Complete sanitation via automatic CIP system
5. Roller conveyors under the dosing and filling platform to eliminate palletizers or similar devices
6. No chemicals or sterile gasses used
7. "Steam only" sterilization of filler heads
8. Increased profitability by keeping constant fill weight accuracy and reducing labor costs



Providing Solutions, Not Just Machinery

As the demand for better, higher-quality value-added berry products intensifies, processors need the best machinery available to maintain and gain greater market share, especially in the face of growing competition. From freezing to filling, JBT offers single machines as well as a complete processing line for creating value-added berry products.

JBT's FLoFREEZE® IQF freezers offer manufacturers proven, cutting edge fluidization technology that help meet the growing demand for frozen berry products.

The JBT family of finishers offers a continuous extraction process with a variety of designs well suited for both juice and puree applications. With over 200 units sold worldwide, JBT's T.A.S.T.E. evaporators and Hybrid evaporators are the industry's choice for concentration operation.

JBT tubular and coiled heat exchangers, available in various configurations and dimensions, ensure uniform heat treatment to berry value-added products, helping preserve their quality, flavor, and texture.

JBT's innovative series of aseptic fillers with easy to operate control systems provide high production speed, fill weight accuracy and reduced labor costs.

With locations in Europe, Latin America and the US, JBT Corporation's Research & Technology Centers offer a range of services including laboratory testing and access to application-specific technology experts. Simply put, JBT Corporation not only provides machinery; it provides solutions to the ever-changing challenges of the global food marketplace.

KEY AUTHORS

Samriddh Mudgal
Food Engineer
Liquid Food Solutions
Sam.Mudgal@JBTC.COM

Danny Milla
R&D Manager
Liquid Food Solutions
Danny.Milla@JBTC.COM

Greg W. Schrader
Director of Integration and Technology Advancement
Liquid Food Solutions
Greg.Schrader@JBTC.COM

References

- Bates, R. P., Morris, J. R., & Crandall, P. G. (2001). *Principles and practices of small-and medium-scale fruit juice processing* (No. 146). Food & Agriculture Org.
- Bower, C. (2007). Postharvest handling, storage, and treatment of fresh market berries. *FOOD SCIENCE AND TECHNOLOGY-NEW YORK-MARCEL DEKKER-*, 168, 261.
- Marra, F., Zhang, L., & Lyng, J. G. (2009). Radio frequency treatment of foods: Review of recent advances. *Journal of Food Engineering*, 91(4), 497-508.
- Mitcham, E. (2007). Quality of berries associated with preharvest and postharvest conditions. *FOOD SCIENCE AND TECHNOLOGY-NEW YORK-MARCEL DEKKER-*, 168, 207.
- Ramaswamy, H. S., & Meng, Y. (2007). Commercial canning of berries. *FOOD SCIENCE AND TECHNOLOGY-NEW YORK-MARCEL DEKKER-*, 168, 335.
- Seeram, N. P. (2008). Berry fruits: compositional elements, biochemical activities, and the impact of their intake on human health, performance, and disease. *Journal of agricultural and food chemistry*, 56(3), 627-629.
- Strik, B. C. (2007). Berry crops: worldwide area and production systems. *Berry Fruit Value Added Products for Health Promotion*, 1, 3-49.
- Wu, X., Beecher, G. R., Holden, J. M., Haytowitz, D. B., Gebhardt, S. E., & Prior, R. L. (2006). Concentrations of anthocyanins in common foods in the United States and estimation of normal consumption. *Journal of Agricultural and Food Chemistry*, 54(11), 4069-4075.
- Zhao, Y. (2007). Freezing process of berries. *FOOD SCIENCE AND TECHNOLOGY-NEW YORK-MARCEL DEKKER-*, 168, 291.



At your service around the globe

North America

John Bean Technologies Corporation
400 Fairway Avenue
Lakeland, FL 33801
USA
Phone: +1.863.683.5411
Fax: +1.863.680.3672
citrus.info@jbtc.com

South America

John Bean Technologies Máq. e Equip. Ind. Ltda.
Av. Eng Camilo Dinucci 4605
14808-900 Araraquara, São Paulo
Brazil
Phone: +55.16.3301.2000
Fax: +55.16.3301.2144
latinamerica.info@jbtc.com

Europe

John Bean Technologies SpA
Via Mantova 63/A
43122 Parma
Italy
Phone: +39.0521.908.411
Fax: +39.0521.460.897
sales.parma@jbtc.com

Asia / Pacific

John Bean Technologies (Shanghai) Co., Ltd.
Room 1908, Hongwell International Plaza,
1600 West Zhongshan Road,
Xuhui District, Shanghai 200235,
PRC
Phone: +86.21.3339.1588
Fax: +86.21.3339.1599
infoasia-jbtfoodtech@jbtc.com



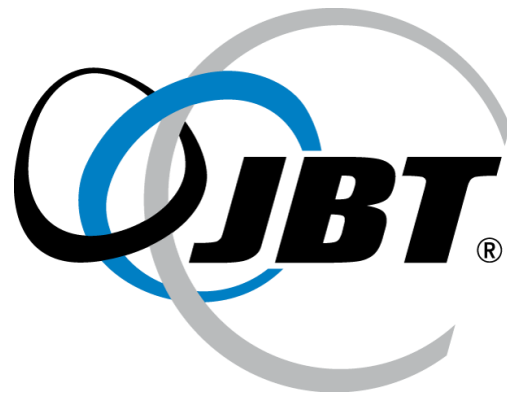

www.jbtcorporation.com